

Updated: 21st December 2009

MB-03 Breakoutboard

User's Guide

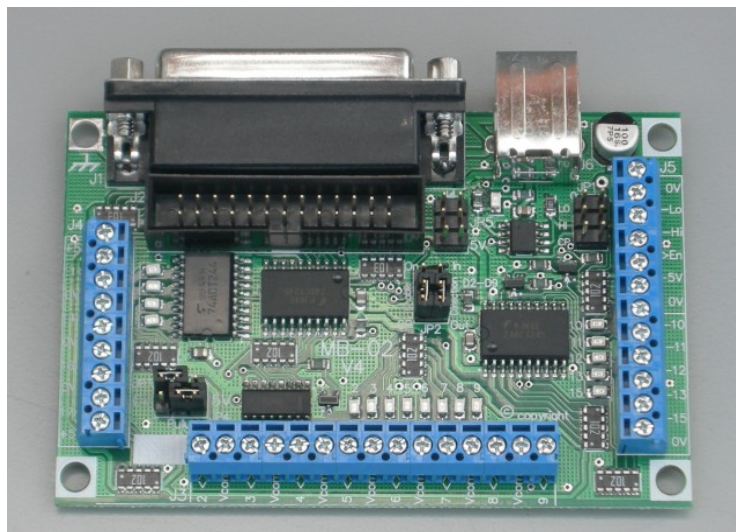

MB-03 PCB Ver: 1
Mach3 Ver: 3.+

Homann Designs

20 View St
HIGHETT VIC, 3190
AUSTRALIA

info@homanndesigns.com
<http://www.homanndesigns.com>

Copyright 2009 © Homann Designs. All rights reserved.

No part of this publication may be reproduced, transmitted, transcribed, stored in a retrieval system, or translated into any language or computer language, in any form or by any means, electronic, mechanical, magnetic, optical, chemical, manual or otherwise, without the prior written permission of Homann Designs.

Disclaimer

Homann Designs makes no representation or warranties with respect to the contents hereof and specifically disclaim any implied warranties or merchantability or fitness for any particular purpose. Information in this publication is subject to change without notice and does not represent a commitment on the part of Homann Designs.

Feedback

We appreciate any feedback you may have for improvements on this document. Please send your comments to info@homanndesigns.com

Trademarks

ModIO™, ModIP™, DigiSpeed™ and DigiSpeed-SD™ are trademarks of Homann Designs. All other brand and product names mentioned herein are trademarks, services marks, registered trademarks, or registered service marks of their respective owners and should be treated as such.

Table of Contents

1	Introduction.....	5
1.1	Contents.....	5
1.2	Overview.....	6
2	Features.....	7
3	Board Description.....	8
3.1	Introduction.....	8
3.2	Power Supply.....	9
3.2.1	Terminal blocks J5.....	9
3.2.2	Pin 26 of IDC connector J2.....	9
3.3	MB-03 Led Indicators.....	10
3.3.1	Status LED.....	10
3.3.2	External Status LED jumper.....	10
3.4	MB-03 Enable Module.....	11
3.4.1	Hi Enable.....	11
3.4.2	Lo Enable.....	11
3.4.3	Status LED.....	11
3.4.4	Enable Jumpers.....	11
3.5	MB-03 Connectors.....	12
3.5.1	J1, J2 Parallel Port Input/Output Connectors.....	13
3.5.2	J3 Port pins D2 to D9 Connector	13
3.5.3	J4 Output Connector Connector	13
3.5.4	J5 Signal, Enable inputs Connector	14
3.5.4.1	Input Signals	14
3.5.4.2	Enable Signals	14
3.6	MB-03 Jumpers.....	15
3.6.1	JP2a D2-D9 Direction Jumper	16
3.6.2	JP2b D2-D9 Enable Jumper	16
3.6.3	JP3 Common terminal Polarity Jumper	17
3.6.4	JP4 Outputs Pull-up/ Pull-down Polarity Jumper	17
3.6.5	JP5a External Status LED Jumper	17
3.6.6	JP5b Pin 26 Power Jumper.....	18
3.6.7	JP5c Enable Override Jumper	18
3.6.8	JP6 Inputs Pull-up/ Pull-down Polarity Jumper	18
3.6.9	JP7 D2-D9 Pull-up/ Pull-down Polarity Jumper	18
4	PCB Layout.....	19
5	MB-03 V1Board Overview.....	20
6	MB-02 to Gecko G251 System Schematic.....	21

Index of Tables

Table 1: Breakout Board Connectors.....	12
Table 2: Board Jumpers.....	15

Illustration Index

Illustration 1: MB-03 Layout.....	8
Illustration 2: PCB Dimensions and Layout.....	19
Illustration 3: MB-03 Breakout Board Overview.....	20
Illustration 4: MB-02 with Gecko G251 System Schematic.....	21

1 Introduction

Thank you for purchasing Homann Designs' MB-03 Bidirectional breakout board. The MB-03 is a breakout board that provides buffering of signals to and from a computer parallel port or Smooth Stepper pulse generator.

This document is a User's Guide that describes the operation of the MB-03. The document contains information on how to use and integrate the board into your own systems.

1.1 Contents

The package received when ordering the MB-03 Breakout board contains the following:

- MB-03 V1 Bidirectional Breakout Board.
- 10 x 0.1" jumpers (installed).
- 4 x 4mm plastic PCB stand-offs.

1.2 Overview

The MB-03 is a simple but robust breakout board that provides a convenient and safe way to interface your CNC components to your PC via the parallel port. Additionally the Breakout board may be used to connect your CNC components to a Smooth Stepper or other motion system.

The MB-03 provides screw terminals for all printer port signals.

The 5Vdc power for the MB-03 can be obtained from pin 26 of the ICD connector or via the 3.5mm screw terminals.

The form factor of the MB-03 Breakout board PCB has been designed for easy installation. Due to its compact size, it can also be easily installed into CNC controller enclosures.

2 Features

The main features of the MB-03 Bidirectional Breakout board are;

- PCB
 - FR4 Material
 - Double Sided, Plated through holes
 - Silk-Screened on Component Side
 - Solder Mask on Both Sides
- Small PCB footprint 92mm(L) x 60mm(W)
- Four 4mm mounting holes (supplied with matching stand-offs)
- Single 5V dc power requirements.
- “Common” supply terminals are selectable as 0V or 5V
- Separate Pullup/down resistors on inputs, outputs and D2-D9 pins ensuring known states
- Each Pull-up/downs voltage selectable between 0V or 5V
- All inputs and outputs are buffered and capable of supplying 24mA
- Inputs can be 3.3V, or 5V logic levels
- Parallel port pins 2-9 can be configured as inputs or outputs via jumper
- DE-25 Female connector and IDC26 header for connection to PC/SmoothStepper.
- Designed to work with popular CNC software such as Mach3, TurboCNC, EMC2, etc.
- Designed to work with popular CNC hardware such as SmoothStepper, GeckoDrive, Rutex, etc
- 3.5mm terminal block connectors for easy installation and maintenance.

3 Board Description

3.1 Introduction

The MB-03 breakout board provides the capability to buffer signal to and from a PC and your CNC controller.

Power for the board may be obtained from Pin 26 of the J2 IDC connector, or from the +5V screw terminals.

The board uses pluggable screw connectors for easy installation and maintenance

LEDs are used for power and enable status indicators.

The pull-ups on inputs, outputs and Pins D2-D9 are selectable between 0V and 5Vdc. This allows the MB-03 to be matched to your CNC hardware requirements.

The “Common” supply pins can be selected to be connected to 0V or 5V, to suit your CNC drive requirements.

Pins 2-9 on the parallel port can be configured to be outputs or inputs, allowing for up to 13 input pins if required. This is useful when using the MB-03 as a 2nd parallel port breakout board. The enable source for these pins can be selected by JP2.

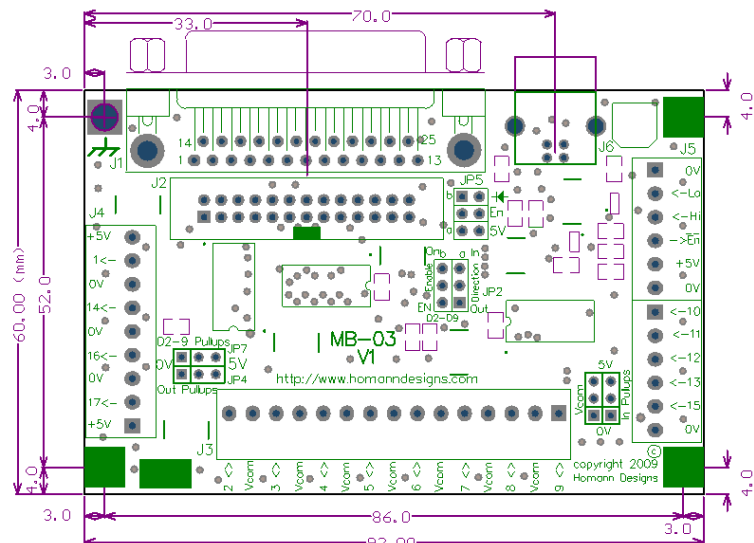

Illustration 1: MB-03 Layout

3.2 Power Supply

The MB-03 requires a 5Vdc power supply to operate. A Power LED located towards the bottom left of the board indicates the presence of the 5Vdc supply

The 5Vdc may be connected to the breakout board by a one of the following three methods.

Note: The MB-03 should be connected to a 5V supply by only one of the following methods.

3.2.1 Terminal blocks J5

The MB-03 terminal blocks contain a number of terminals that are marked 5V and 0V. Any of these may be used to connect the 5Vdc to the board from an external supply.

Note: This is the preferred and most reliable way to apply power to the board.

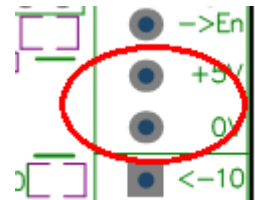

3.2.2 Pin 26 of IDC connector J2

Pin 26 of the IDC connector J2 on the MB-03 is connected to the 5Vdc supply on the board. This can be used to power the board from another device such as the Smooth Stepper. Conversely, the Smooth Stepper could be powered from the MB-03 breakout board. This option is selected by inserting the jumper into JP5 as shown.

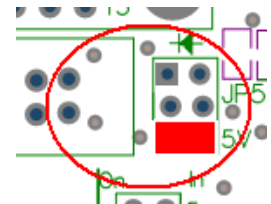

3.3 MB-03 Led Indicators

The MB-03 breakout board contains LED indicators that display the status of the board and the parallel port signals. Their function is described below.

3.3.1 Status LED

The status led located towards the top right on the MB-03 indicates the status of the enable inputs.

- LED On – Indicates that the printer port output lines Pin2-Pin9 and pins 1,14,16,17 are enabled.
- LED Off – Indicates that not all of the enable conditions are present and the printer port output lines are not enabled.

3.3.2 External Status LED jumper

Jumper J5a provides for an external status led to be connected to the board. The polarity of the LED is marked on the PCB silkscreen adjacent to the jumper. The jumper is connected to a current limiting resistor, so a bare LED may be connected.

3.4 MB-03 Enable Module

The MB-03 breakout board contains an Enable Module. This module monitors the state of the **Enable Hi**, and **Enable Lo** signal inputs. If either of these inputs are in their active state, the MB-03 Enable Signal output will be active.

Note: the Enable Output signal is Active Lo

In addition to the Enable Output signal, the signal can also be used to enable/disable the buffers controlling the printer port output signals 2 – 9, 1,14, 16 and 17.

3.4.1 Hi Enable

For this signal to be active, a logic hi (5V) signal must be present on the **Enable Hi** input

3.4.2 Lo Enable

For this signal to be active, a logic lo (0V) signal must be present on the **Enable Lo** input

3.4.3 Status LED

The status led located towards the top right on the MB-03 indicates the status of the enable inputs.

- LED On – Indicates that the printer port output lines Pin2-Pin9 and pins 1,14,16,17 are enabled.
- LED Off – Indicates that not all of the enable conditions are present and the printer port output lines are not enabled.

3.4.4 Enable Jumpers

There are 2 jumpers associated with the MB-03 Enable Module, JP5c the Enable override jumpers and JP2a :

- JP5c – Overrides the need for an external Enable input when inserted.
- JP2a – Enable Continuously enables the D2 –D9 pins when inserted in the 'ON' position. This is useful when these pins are used as inputs into the parallel port.

3.5 MB-03 Connectors

The MB-03 breakout board contains the connectors as identified in Table 1 below. Their use is described in more detail in the following subsections.

<i>Connector</i>	<i>Type</i>	<i>Description</i>
J1	DB-25 Female	Parallel Port Connector
J2	26 pin 2x13 IDC box header	Parallel port ribbon cable connector
J3	12 way 3.5mm Terminal Block	Parallel Port Input/Output Pins 2 - 9
J4	12 way 3.5mm Terminal Block	Parallel Port Output Pins 1, 14, 16 and 17
J5	12 way 3.5mm Terminal Block	Parallel Port Input Pins 10, 11, 12, 13 and 15. Enable inputs and Power.

Table 1: Breakout Board Connectors

3.5.1 J1, J2 Parallel Port Input/Output Connectors

The MB-03 contains two different connectors for connecting the board to a PC. J1 is a standard DB25 female connector commonly used on parallel port printers. This allows the use of standard printer cables.

The other connector J2 is a 26 pin IDC box header. This can be used with a standard 26 pin IDC to DB25 cable as found in many PCs. This connector caters for installations

where the breakout board cannot be mounted on the edge of an enclosure to expose the parallel port connector J1.

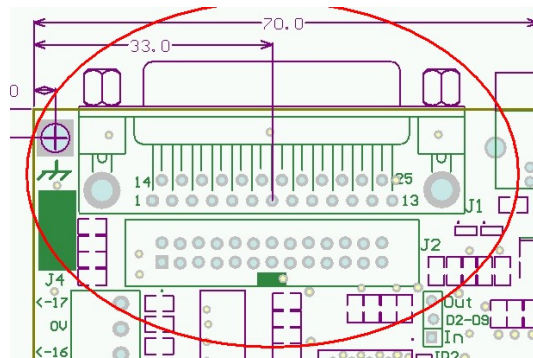

3.5.2 J3 Port pins D2 to D9 Connector

J3 on the MB-03 contains terminals for the parallel port D2 to D9 signals. In addition to these, there is also a Vcom terminal for each pair of the parallel port signals. Each of these parallel port signals are buffered and may be configured as inputs or outputs. Additionally each signal has a pull up/down resistor on each side of each buffer.

There is also labeled led indicators to show the state of each of the signals.

There is also labeled led indicators to show the state of each of the signals.

3.5.3 J4 Output Connector Connector

J4 on the MB-03 contains terminals for the parallel port output signals 1, 14, 16, and 17.

Each of these parallel port output signals are buffered. Additionally each signal has a pull up/down resistor on each side of each buffer.

There is also labeled led indicators to show the state of each of the signals.

3.5.4 J5 Signal, Enable inputs Connector

J5 on the MB-03 contains terminals for 5V power, signal inputs and the enable inputs as described below.

3.5.4.1 Input Signals

J5 contains terminals for 5 inputs that connect to parallel port pins 10, 11, 12, 13 and 15. Each of these inputs are buffered to protect the parallel port and have a pull up/down resistor on both sides of the buffer.

Each input is designed to accept a 0 or 5V digital input. The inputs terminals are labels to indicated which parallel port pin they are connected to.

Each input also has a led to indicate the signal status.

3.5.4.2 Enable Signals

J5 contains two terminals for enable inputs. There is a Hi Enable input and a Lo enable input. Each of these inputs are buffered and have a pull up/down resistor to put the input into an inactive state when left unconnected. **Either** signals need to be asserted to the correct state, for the system enable to be active. Each input is designed to accept a 0 or 5V digital input.

There is also an enable output on this connector. This is an Active Lo (0V) logic signal that may be used for enable control of external devices.

3.6 MB-03 Jumpers

The MB-03 has four jumpers that configure the boards functionality. They are identified in Table 2 below. Their use is described in more detail in the following subsections.

<i>Jumper</i>	<i>Name</i>	<i>Description</i>	<i>Position 1-2</i>	<i>Position 2-3 or not inserted</i>
JP2a	D2-D9 Direction	Selects whether port pins 2-9 are inputs or Outputs	Selects the pins as outputs.	Selects the pins as inputs.
JP2b	D2-D9 Enable source	Selects the source for the pins buffer enable	Enable from the system enable	Always enabled
JP3	Vcom Polarity	Selects whether the Vcom pins have 5V or 0V on them	Sets the Vcom pins to 0V	Sets the Vcom pins to 5Vdc
JP4	Outputs Pull-up Polarity	Selects whether the board pull-ups are connected to 5V or 0V	Sets the pull-ups to 0V	Sets the pull-ups to 5Vdc
JP5a	Pin 26 Power	Connects pin 26 of J2 to the 5V supply.	J2 Pin 26 connected to 5V supply	Not connected.
JP5b	External status LED	Allows an external status LED to be connected	Connect LED as per legend on the PCB	Not Connected.
JP5c	Enable Override	Enables the board when external enable inputs are not used.	Board is enabled regardless of the enable input state	Board must be enabled by the external inputs when not inserted.
JP6	Inputs Pull-up Polarity	Selects whether the board pull-ups are connected to 5V or 0V	Sets the pull-ups to 0V	Sets the pull-ups to 5Vdc
JP7	D2-D9 Pull-up Polarity	Selects whether the D2-D9 pins pull-ups are connected to 5V or 0V	Sets the pull-ups to 0V	Sets the pull-ups to 5Vdc

Table 2: Board Jumpers

3.6.1 JP2a D2-D9 Direction Jumper

On a parallel port , pins 2 to 9 can be configured to be outputs or inputs. The pins are configured as outputs by default and can be changed to inputs via software control. Jumper JP2a on the MB-03 breakout board changes the direction of the buffer drivers so they can match the direction of the configured parallel port pins.

It is not uncommon for the pin on a 2nd parallel port to be configured as inputs so as to expand the number of available inputs to the system.

Jumper JP2a has two positions, “Out” and “In”. If a jumper is placed across pins 2-3, toward the Out label end , the buffer drivers for pins 2-9 are configured as outputs. If a jumper is placed across pins 1-2, toward the In label end, the buffer drivers for pins 2-9 are configured as inputs. The image shows the jumper to set this signals as outputs.

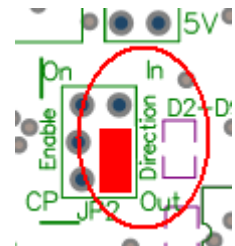

3.6.2 JP2b D2-D9 Enable Jumper

The enable control of the buffer drivers for pins 2 to 9 can be configured to to be controlled by the system enable signal or configured to be permanently on.

When pins 2 to 9 are configured as outputs they should be controlled by the system enable signal. When these pins are configured as inputs, it may be desirable to have these pins permanently enabled like the other input pins on the MB-03. The image shows the enable for these pins being controlled by the system enable signal.

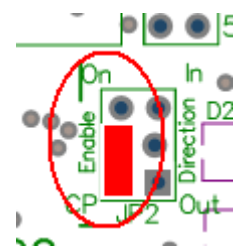

3.6.3 JP3 Common terminal Polarity Jumper

The MB-03 contains a number of screw terminals labeled “Vcom”. Jumper JP3 is used to select the voltage that is presented on these pins. The Vcom terminals are usually connected to the Common terminal for the Step and Dir inputs on stepper drivers. This voltage may be 0V or 5Vdc. The position of this jumper will be dependent on the devices connected to the MB-03.

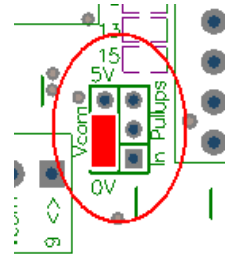

Jumper LP3 has two positions, “0V” and “5V”. If a jumper is placed across pins 1-2, the “0V” position, the Vcom terminal will be connected to 0V of the power supply. If a jumper is placed across pins 2-3, the “5V” position, the Vcom terminal will be connected to the 5Vdc power supply rail. The image shows the jumper in the 5V Vcom position.

3.6.4 JP4 Outputs Pull-up/ Pull-down Polarity Jumper

The MB-03 contains Pull-up/ Pull-down resistors on all of the parallel port signals in addition to the signals on terminals J3, J4 and J5. These resistors ensures that the signals are in a known state when not being driven and do not “float” causing spurious inputs or outputs.

JP4 controls the state of the pullup resistors for the Parallel port output pins 1, 14, 16 and 17. Setting the jumper toward the 0V label end of the jumper will cause the signals to be pulled-down to 0V. Setting the jumper toward the 5V label end will cause the signals to be pulled-up to 5V. The image shows the jumper in the 0V (pull-down) position.

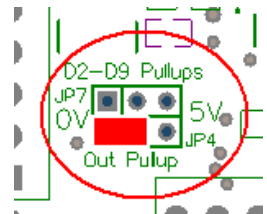

3.6.5 JP5a External Status LED Jumper

The MB-03 contains a jumper that allows an external status LED to be connected. This jumper is connected to a current limiting resistor so a bare LED indicator may be fitted.

The polarity of LED connection is shown on the pcb silkscreen.

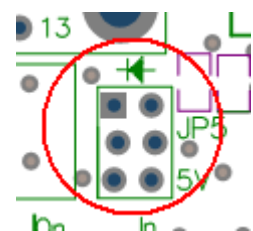

3.6.6 JP5b Pin 26 Power Jumper

The MB-03 contains a jumper that allows pin 26 of Connector J2 to be connected to the 5V power supply. Image shows the jumper inserted.

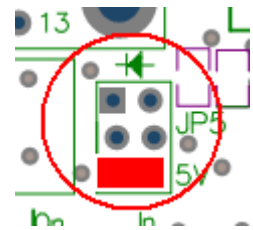

3.6.7 JP5c Enable Override Jumper

The Enable Override Jumper JP5c can be used to override the external Active Hi, Active Lo Enable inputs on J5. By inserting the jumper into the corresponding position, the enable inputs will be overridden.

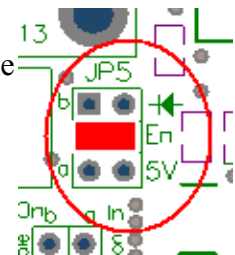

3.6.8 JP6 Inputs Pull-up/ Pull-down Polarity Jumper

JP6 controls the state of the pullup resistors for the Parallel port input pins 10, 11, 12, 13 and 15. Setting the jumper toward the 0V label end of the jumper will cause the signals to be pulled-down to 0V. Setting the jumper toward the 5V label end will cause the signals to be pulled-up to 5V. The image shows the jumper in the 0V (pull-down) position.

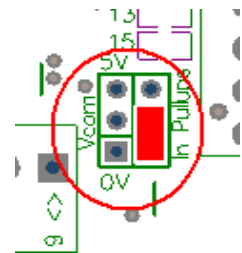

3.6.9 JP7 D2-D9 Pull-up/ Pull-down Polarity Jumper

JP7 controls the state of the pullup resistors for the Parallel port input/output pins 2 - 9. Setting the jumper toward the 0V label end of the jumper will cause the signals to be pulled-down to 0V. Setting the jumper toward the 5V label end will cause the signals to be pulled-up to 5V. The image shows the jumper in the 0V (pull-down) position.

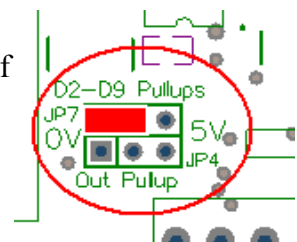

4 PCB Layout

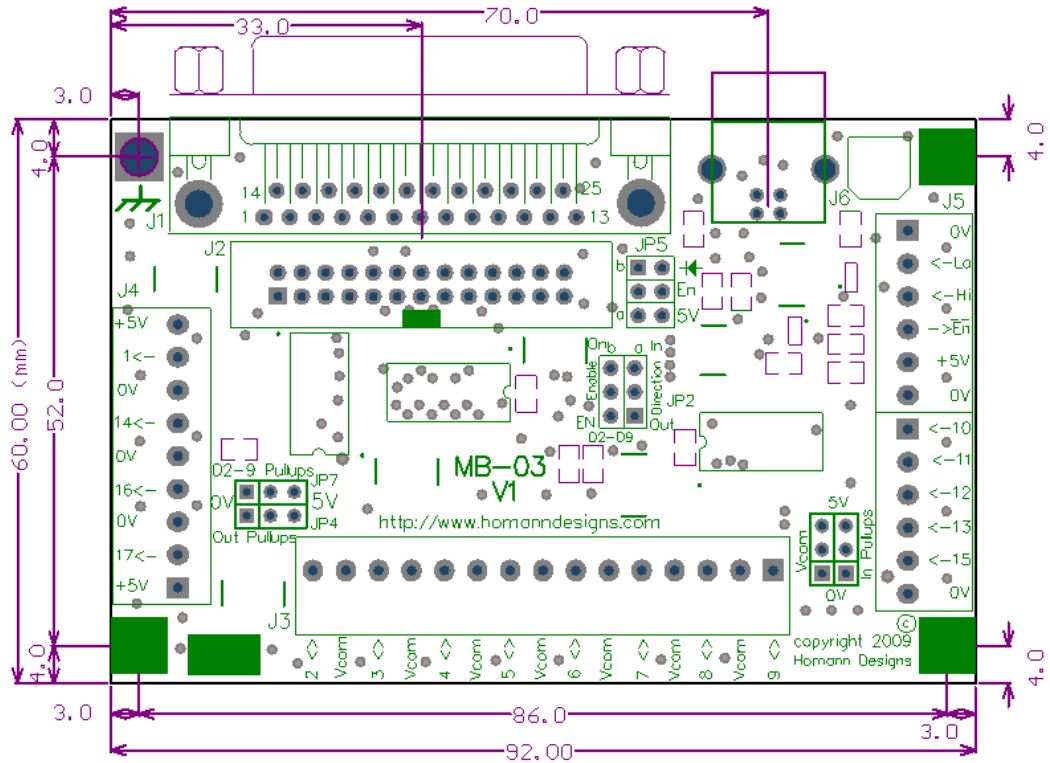

Illustration 2: PCB Dimensions and Layout

5 MB-03 V1Board Overview

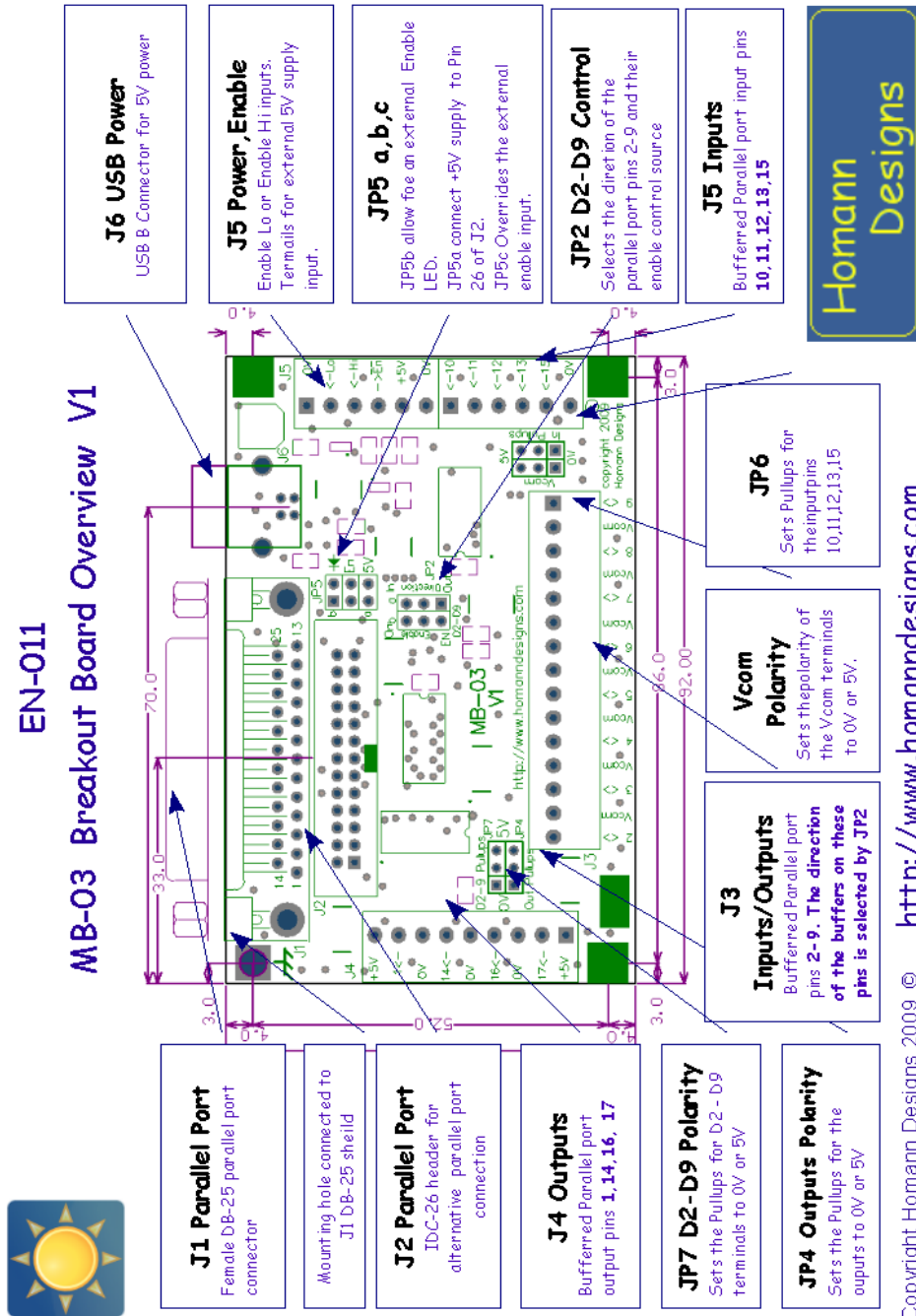

Illustration 3: MB-03 Breakout Board Overview

